

HOBART701 S Ridge Avenue, Troy, OH 45374
1-888-4HOBART • www.hobartcorp.com**FP300
FOOD PROCESSOR****HOBART****STANDARD FEATURES**

- Red OFF, Green ON Button
- Compact Design
- Angled Front
- Planetary Drive
- Large Half Size Feed Hopper
- All Aluminum Hopper and Housing
- Double Interlock Switch
- Plate Speed of 430 RPMs

OPTIONS

- Maximum Security Correctional Package

ACCESSORIES

- 3-Pack Plates: $\frac{1}{16}$, $\frac{5}{32}$ slicer plates, $\frac{3}{16}$ shredder plate, 1 wall rack
- 6-Pack Plates: $\frac{1}{16}$, $\frac{5}{32}$, $\frac{3}{8}$, $\frac{7}{32}$ slicer plates, $\frac{3}{16}$ shredder plate and $\frac{3}{8}$ dicer plate, 2 wall racks
- 3-Peg Wall Rack: designed to hold three plates for additional plate storage
- Slicer Plates: $\frac{1}{16}$, $\frac{1}{8}$, $\frac{5}{32}$, $\frac{3}{8}$, $\frac{3}{8}$ HD, $\frac{7}{32}$ and $\frac{9}{16}$; $\frac{3}{16}$ crimping plate
- Julienne Plates: $\frac{3}{32}$, $\frac{3}{16}$, $\frac{7}{32}$, $\frac{3}{8}$
- Dicer Grids: $\frac{9}{32}$, $\frac{3}{8}$, $\frac{1}{2}$, $\frac{5}{8}$, $\frac{3}{4}$, and 1; soft dice $\frac{5}{16}$, $\frac{3}{8}$, $\frac{1}{2}$, $\frac{5}{8}$

*NOTE: The $\frac{3}{4}$ dicer grid or the 1" dicer grid should be used with the $\frac{9}{16}$ slicer plate only.

- Shredder Plates: $\frac{1}{16}$, $\frac{3}{32}$, $\frac{1}{8}$, $\frac{3}{16}$, $\frac{5}{16}$, $\frac{7}{32}$
- Grater Plate: Fine
- French Fry: $\frac{3}{8}$
- Machine Table: Adjustable height table to hold Food Processor
- Adjustable height stainless steel lug cart
- Stainless steel receiving pan
- Plastic receiving pan

MODELS

- FP300 Continuous Feed Half Size Hopper Food Processor

Specifications, Details and Dimensions on Inside and Back.

**FP300 FOOD PROCESSOR**

FP300 FOOD PROCESSOR



701 S Ridge Avenue, Troy, OH 45374
1-888-4HOBART • www.hobartcorp.com

SOLUTIONS/BENEFITS

Red OFF, Green ON Button

Ease of use

- Operator can readily recognize

Compact Design

Ease of use, small footprint, reduced labor, increased sanitation and productivity

- Occupies minimal counter space
- Unit and receiving pan fit on 27" deep counter
- Plates remove in seconds
- Feed hopper removes without tools for ease of cleaning
- Produces consistent quality product results in seconds
- Production capability for 16 lbs. per minute

Angled Front

Operator convenience, ease of use

- 45° angle for ease of product loading
- Helps to reduce operator fatigue

Planetary Drive

Performance, reliability

- Helps to prevent stalling under heavy loads
- No rest times required between loads

Large Half Size Feed Hopper

Flexibility, convenience, reduced labor

- Supports processing capabilities for large variety of products
- Design permits continuous cutting of long products
- Eliminates precutting

All Aluminum Hopper and Housing

Durability, sanitation

- Anodized finish resists harsh cleaners
- Easy clean up

Double Interlock Switch

Protection

- Prevents machine from running when pusher plate swings away or is open

Plate Speed of 430 RPM

Product quality and consistency

- Precise cutting and dicing action without bruising or mashing of products

3 PAK



1/16" Slicing Plate



5/32" Slicing Plate



3/16" Shredder Plate



Wall Rack

6 PAK 3 Pack Plus



7/32" Slicing Plate



3/8" HD Slicing Plate

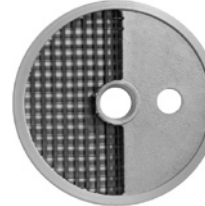

3/8" Dicing Plate

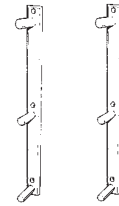

(2) Wall Racks



701 S Ridge Avenue, Troy, OH 45374
1-888-4HOBART • www.hobartcorp.com

FP300 FOOD PROCESSOR

SPECIFICATIONS

DESIGN: Compact, conveniently designed at 45° angle for operator convenience. Base occupies minimal counter space. Housing constructed of anodized aluminum with rubber feet on base to prevent movement or skidding. Removable hopper front is burnished aluminum.

ELECTRICAL: 120/60/1, 3 Conductor power cord (14 AWG) is 6 feet in length.

MOTOR: 10 amps. Gear driven operating at 430 RPM output. 1 H.P. with overload protection.

SWITCHES: Easy to operate (red) OFF and (green) ON switch. Pusher plate and hopper front are interlocked.

STANDARD EQUIPMENT: Basic unit comes with deflector plate and cleaning brush.

WARRANTY: Unit has full one-year warranty on parts, labor and mileage against manufacturer's defects. Service contracts are available.

CUTTING TOOLS: Plates feature aluminum or acetal thermoplastic supports combined with cutlery grade stainless steel cutting surfaces.

WEIGHT: Net - 66 lbs. Approximate Shipping - 72 lbs.

ASSEMBLY PARTS

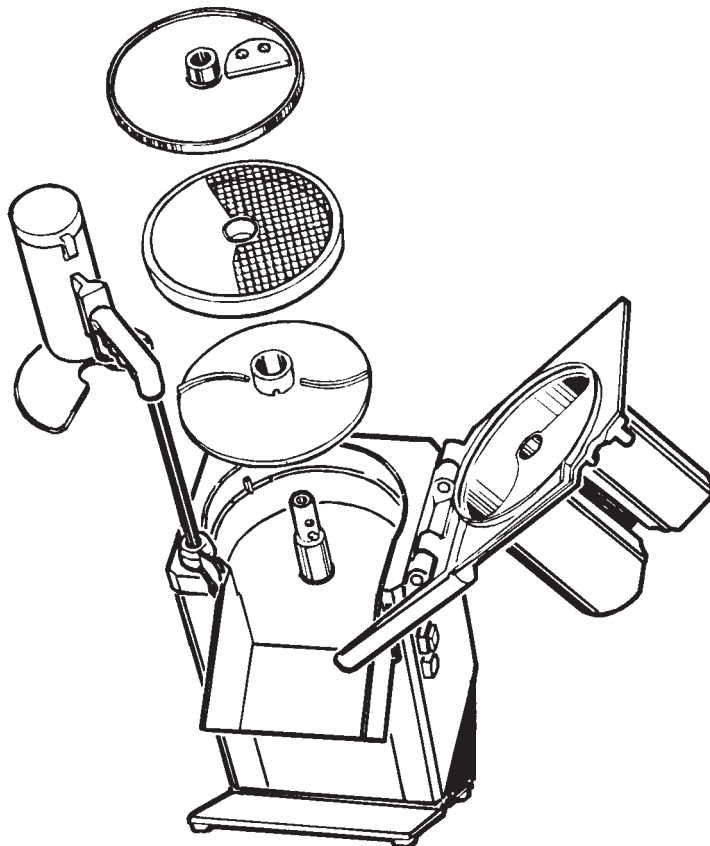

PRODUCT LOADING

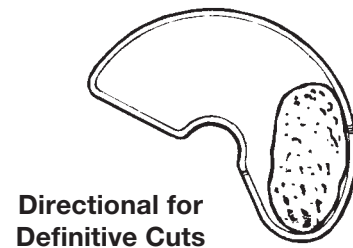
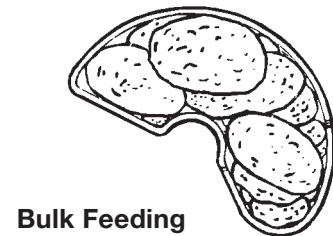

FP300 FOOD PROCESSOR



701 S Ridge Avenue, Troy, OH 45374
1-888-4HOBART • www.hobartcorp.com

DETAILS AND DIMENSIONS

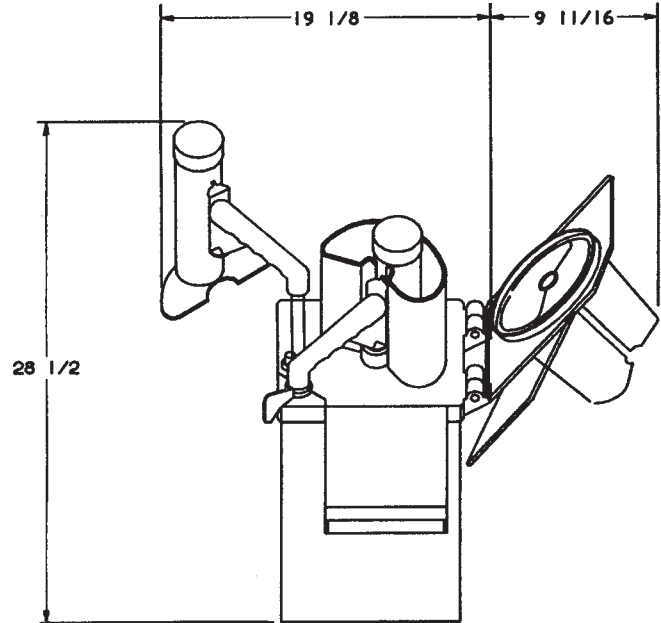
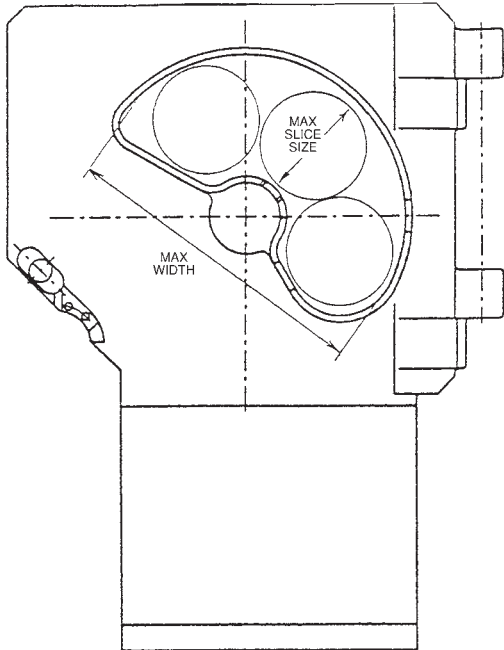

FP300

Hopper Diameter	7 ³ / ₈ "
Maximum Slice Size	3"
Usable Depth	7"
Feed Tube Diameter	2 ⁵ / ₁₆ "

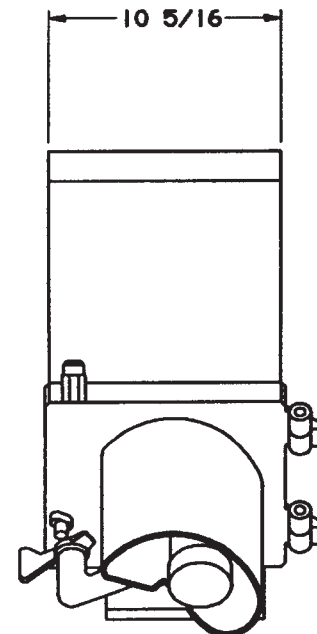
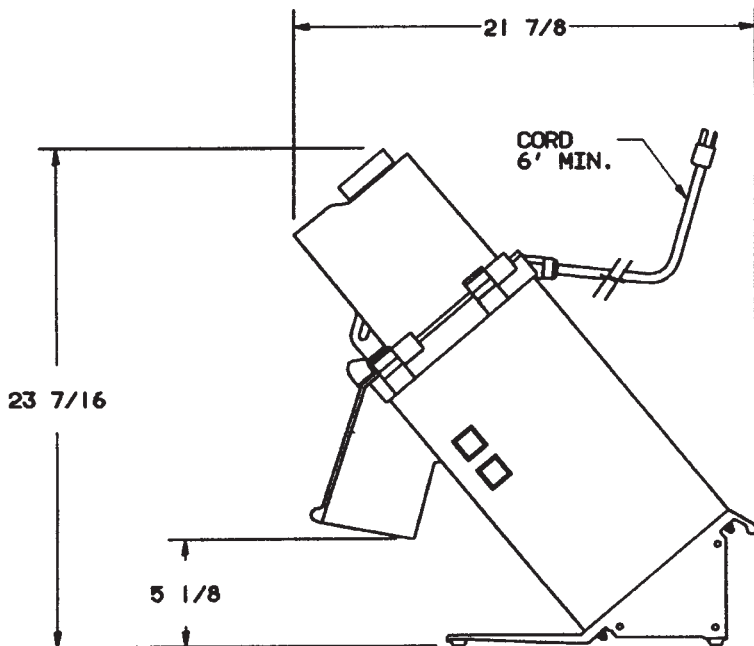

As continued product improvement is a policy of Hobart, specifications are subject to change without notice.